

**Ensemble partie basse**  
**Lower End Assembly**  
**Unteres Ende Bausatz**

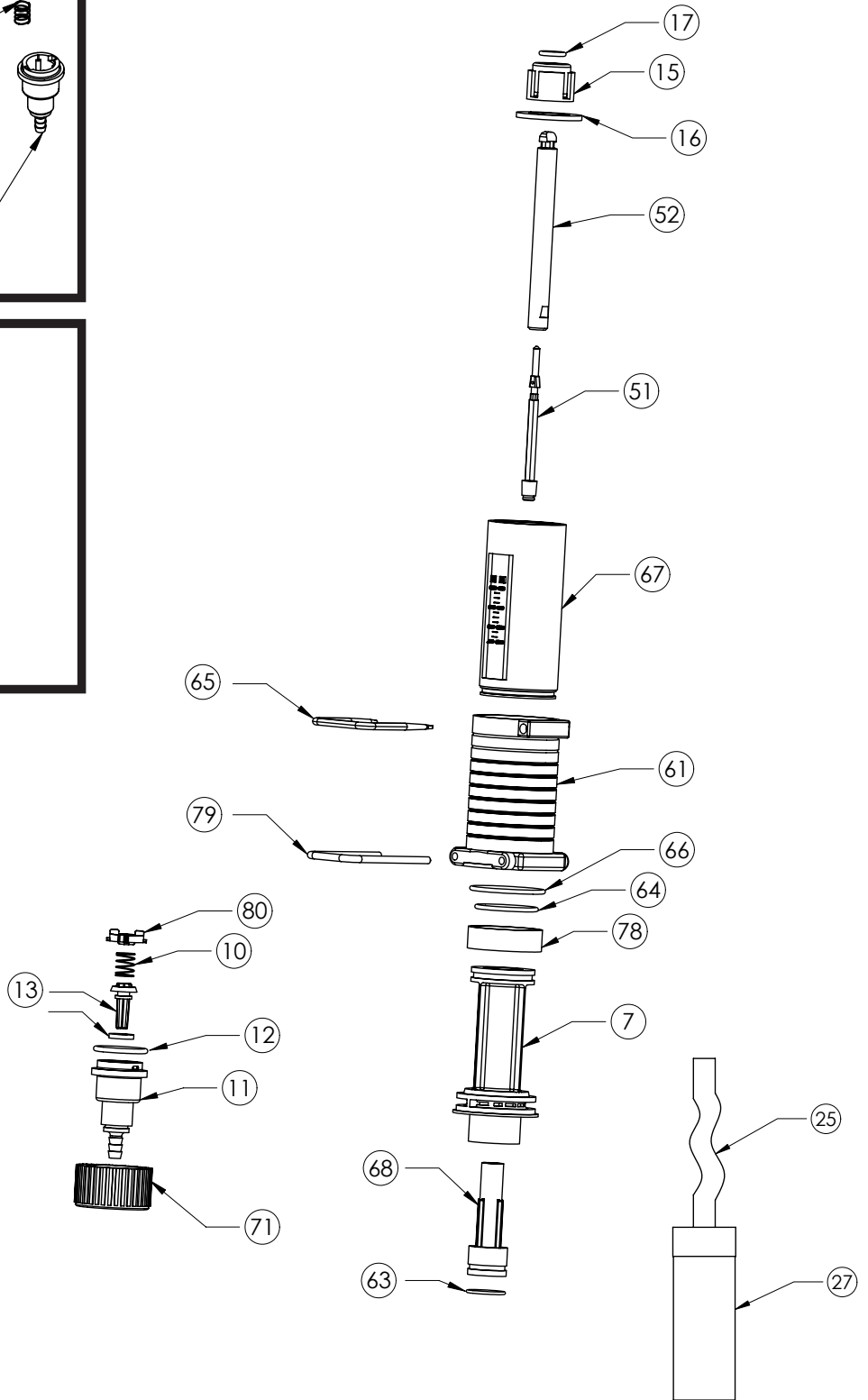

4690411 - 01/2014